

Quilt Sudoku marron

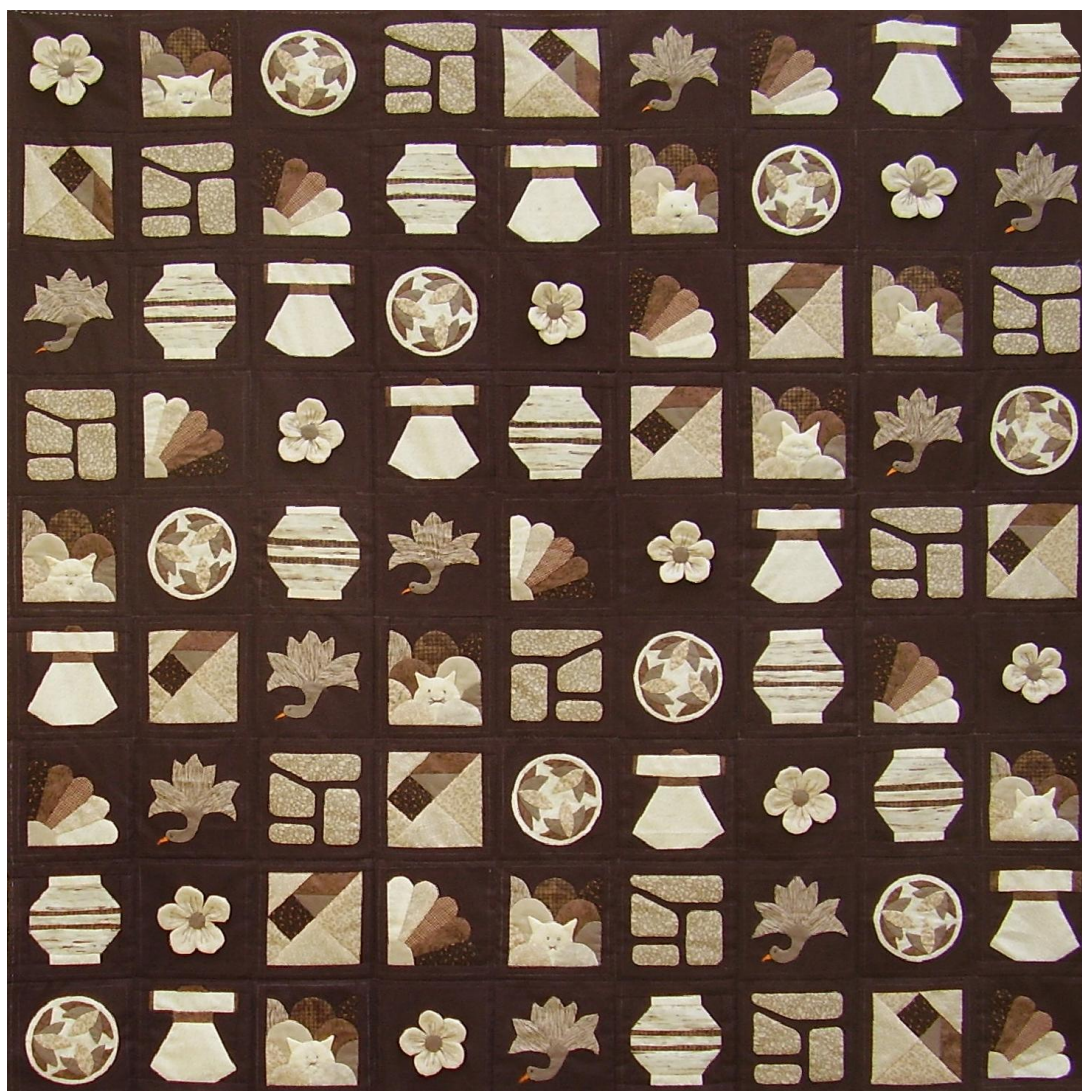

1,08 m X 1,08 m

Les blocs



Les blocs mesurent 12 cm X 12 cm (coutures non comprises)



Kimono

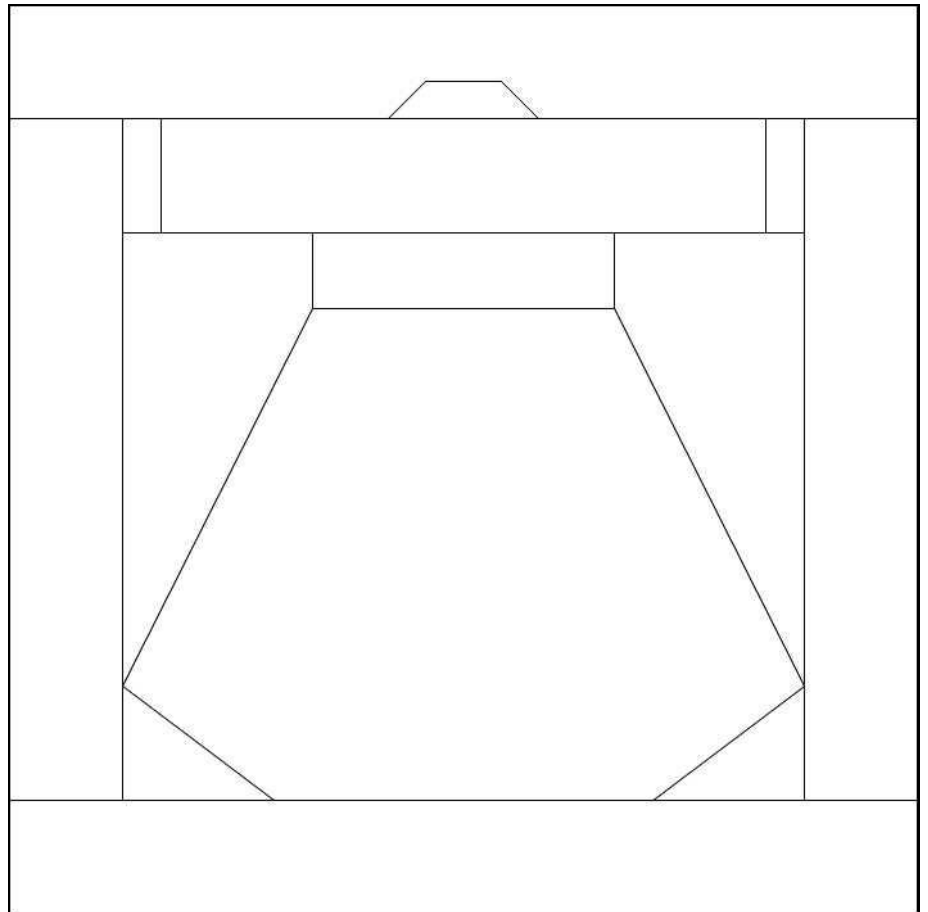

Le col est réalisé en pliage.



Lanterne

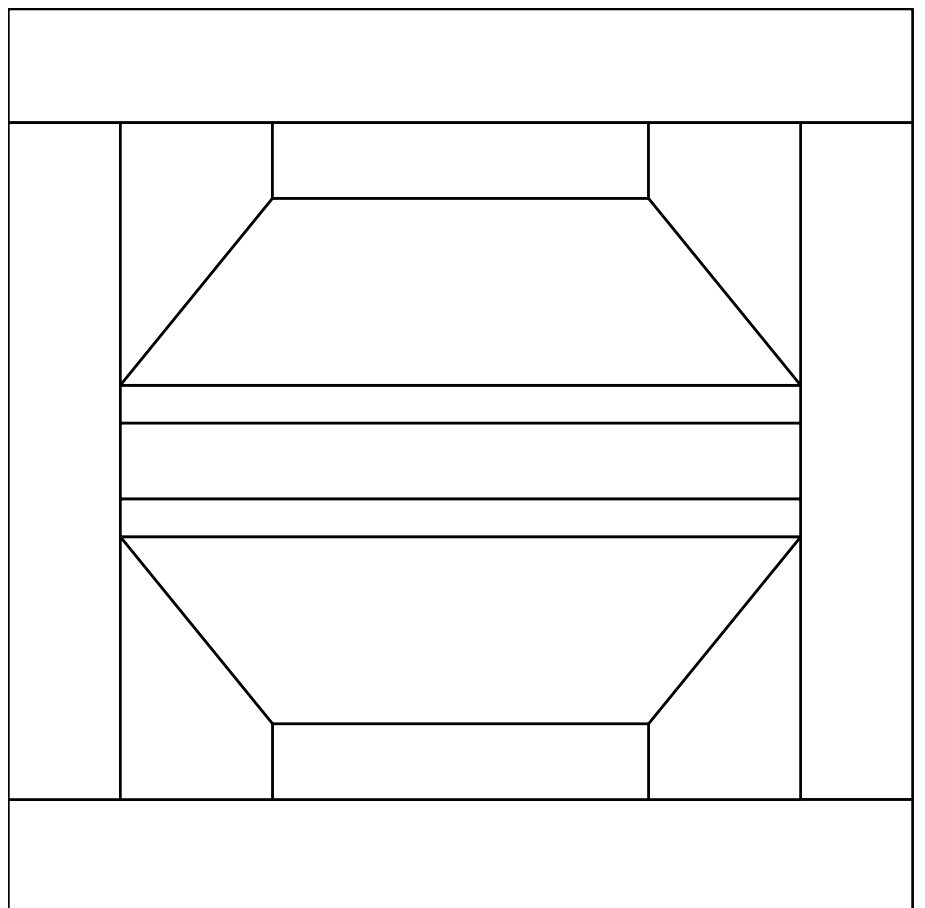



Tam gram

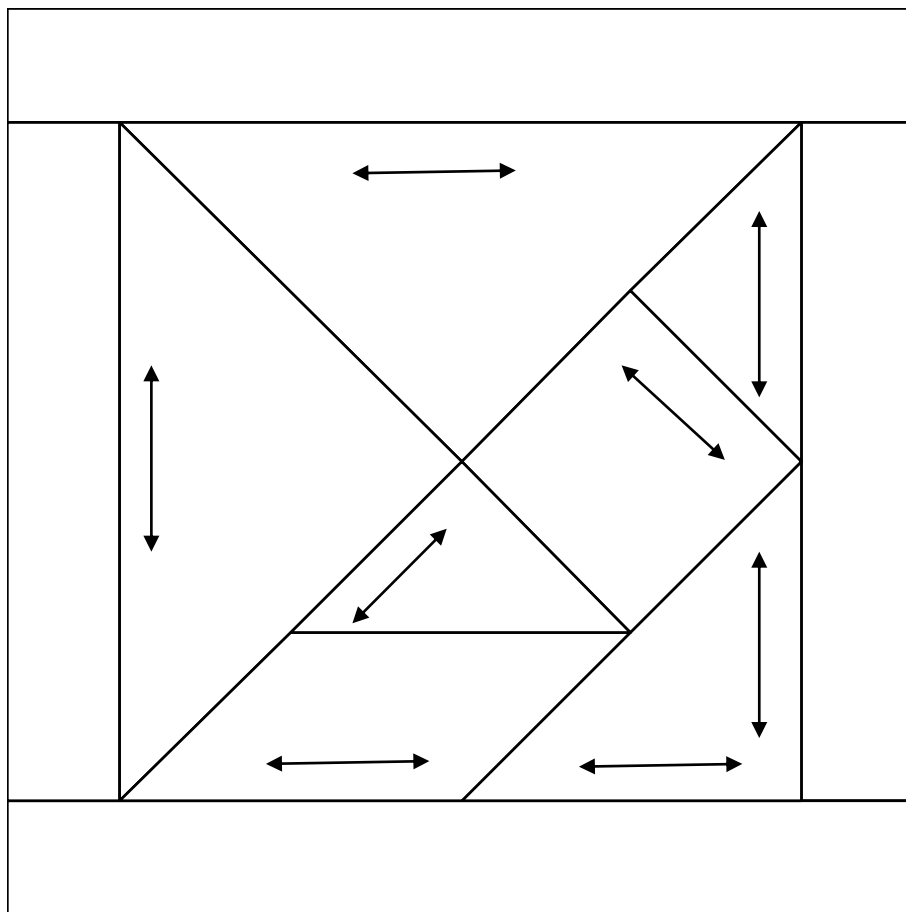

Attention au droit fil.



Grue

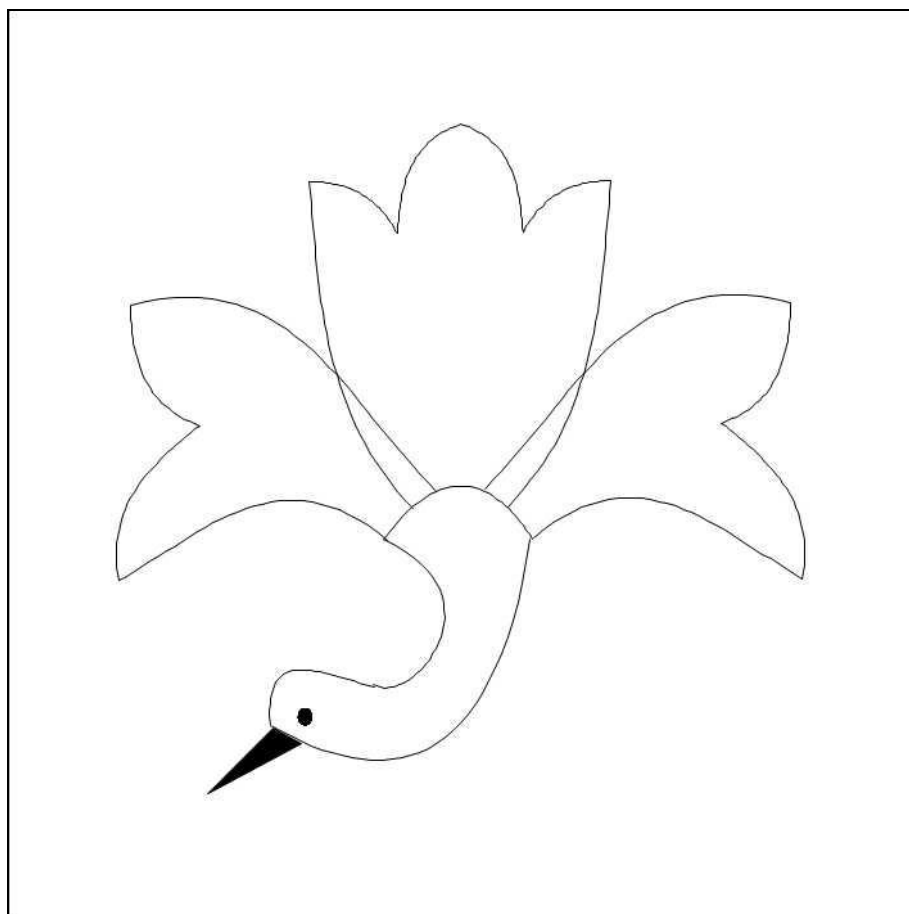

L'œil et le bec sont brodés.



Quart de
chrysanthème

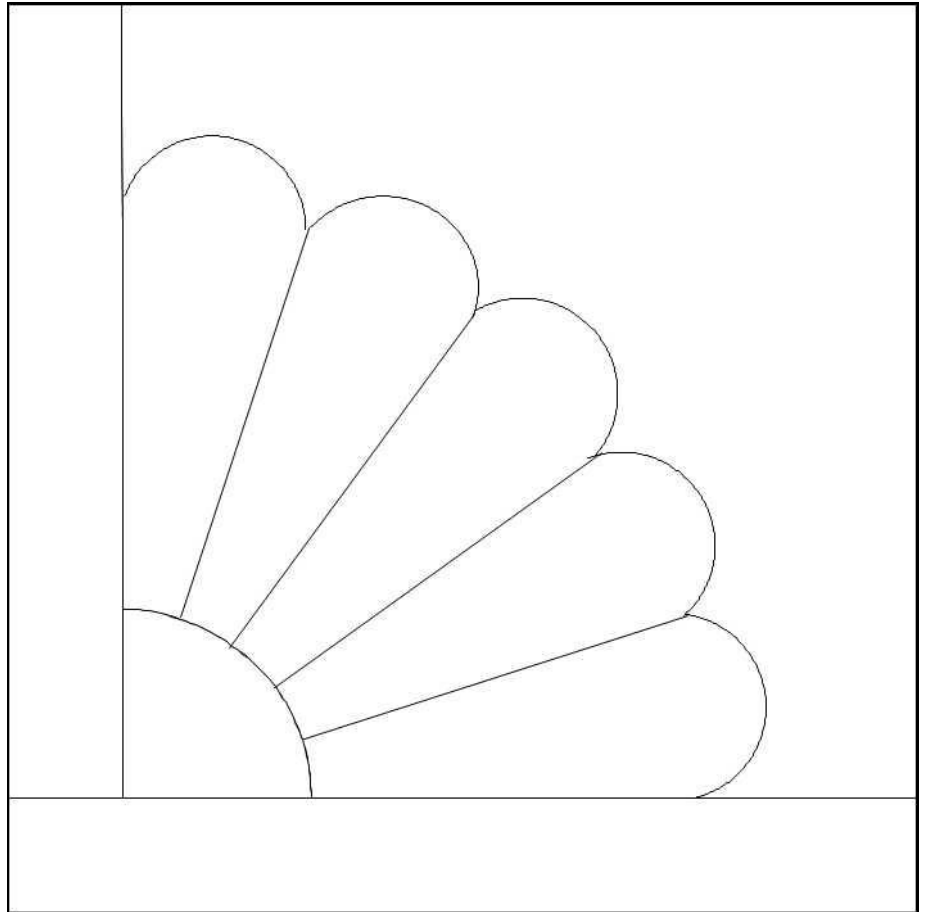

Fleur de cerisier
en 3 D



Gabarit d'un pétale (à faire 10 fois).

Gabarit du centre : une pièce de 1 centime d'euro (à faire 5 fois).

Les étamines sont brodées.

Fixer la fleur préalablement « construite » sur un fond de 12 cm X 12 cm
(Coutures non comprises)



Eailles - Chat

Les oreilles sont réalisées en pliage, les yeux et la moustache sont brodés.

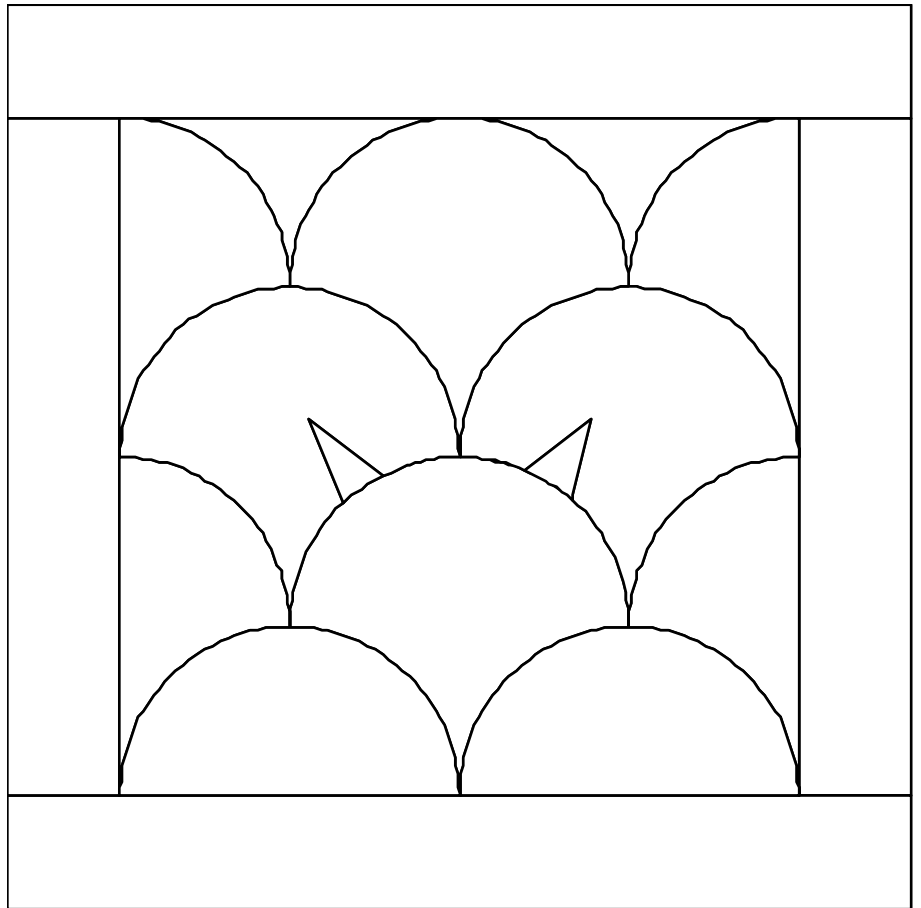

Pas japonais

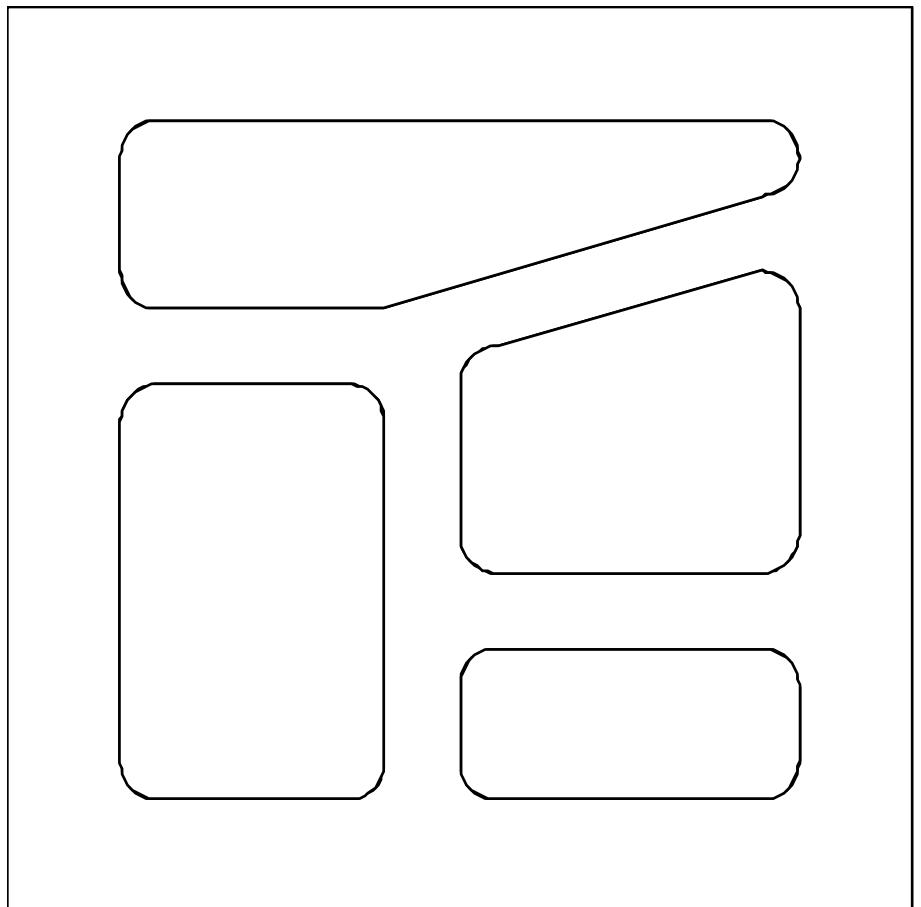



Bambou

Insérer en appliqué inversé le cercle clair de 9 cm de diamètre dans le fond, puis appliquer les feuilles en appliqué traditionnel.

